



GRE[®] Physics Test Practice Book

This practice book contains

- one full-length *GRE*[®] Physics Test
- test-taking strategies

Become familiar with

- test structure and content
- test instructions and answering procedures

Compare your practice test results with the performance of those who took the test at a GRE administration.

www.ets.org/gre

Table of Contents

Overview.....	3
Test Content	3
Preparing for the Test.....	4
Test-Taking Strategies.....	4
What Your Scores Mean	4
Taking the Practice Test	5
Scoring the Practice Test	5
Evaluating Your Performance	5
Practice Test.....	7
Worksheet for Scoring the Practice Test	25
Score Conversion Table.....	26

Test takers with disabilities or health-related needs who need test preparation materials in an alternate format should contact the ETS Office of Disability Services at stassd@ets.org. For additional information, visit www.ets.org/gre/test-takers/subject-tests/register/disability-accommodations.html.

Overview

The GRE® Physics Test consists of about 70 multiple-choice questions. Testing time is 2 hours; there are no separately-timed sections.

This publication provides a comprehensive overview of the GRE Physics Test to help you get ready for test day. It is designed to help you:

- Understand what is being tested
- Gain familiarity with the question types
- Review test-taking strategies
- Understand scoring
- Practice taking the test

To learn more about the GRE Subject Tests, and their computer-based administration beginning in September 2023, visit www.ets.org/gre/test-takers/subject-tests/about.html.

Test Content

The approximate distribution of questions by content category is shown below.

- I. **Classical Mechanics (20%)**
(such as kinematics, Newton's laws, work and energy, oscillatory motion, rotational motion about a fixed axis, dynamics of systems of particles, central forces and celestial mechanics, three-dimensional particle dynamics, Lagrangian and Hamiltonian formalism, non-inertial reference frames, elementary topics in fluid dynamics)
- II. **Electromagnetism (18%)**
(such as electrostatics, currents and DC circuits, magnetic fields in free space, Lorentz force, induction, Maxwell's equations and their applications, electromagnetic waves, AC circuits, magnetic and electric fields in matter)
- III. **Optics and Wave Phenomena (8%)**
(such as wave properties, superposition, interference, diffraction, geometrical optics, polarization, Doppler effect)
- IV. **Thermodynamics and Statistical Mechanics (10%)**
(such as the laws of thermodynamics, thermodynamic processes, equations of state, ideal gases, kinetic theory, ensembles, statistical concepts and calculation of thermodynamic quantities, thermal expansion and heat transfer)
- V. **Quantum Mechanics (13%)**
(such as fundamental concepts, solutions of the Schrödinger equation [including square wells, harmonic oscillators and hydrogenic atoms], spin, angular momentum, wave function symmetry, elementary perturbation theory)
- VI. **Atomic Physics (10%)**
(such as properties of electrons, Bohr model, energy quantization, atomic structure, atomic spectra, selection rules, black-body radiation, x-rays, atoms in electric and magnetic fields)
- VII. **Special Relativity (6%)**
(such as introductory concepts, time dilation, length contraction, simultaneity, energy and momentum, four-vectors and Lorentz transformation, velocity addition)
- VIII. **Laboratory Methods (6%)**
(such as data and error analysis, electronics, instrumentation, radiation detection, counting statistics, interaction of charged particles with matter, lasers and optical interferometers, dimensional analysis, fundamental applications of probability and statistics)
- IX. **Specialized Topics (9%)**
Nuclear and Particle physics (such as nuclear properties, radioactive decay, fission and fusion, reactions, fundamental properties of elementary particles), Condensed Matter (such as crystal structure, x-ray diffraction, thermal properties, electron theory of metals, semiconductors, superconductors), Miscellaneous (such as astrophysics, mathematical methods, computer applications)

The Physics Test administered beginning in September 2023 yields a total scaled score and three percent correct scores in the following content areas:

- Classical Mechanics
- Electromagnetism
- Quantum Mechanics and Atomic Physics

The questions on which percent correct scores are based are distributed throughout the test; they are not set aside and labeled separately, although several questions from a single content area may appear consecutively.

Preparing for the Test

GRE Subject Test questions are designed to measure skills and knowledge gained over a long period of time. Although you might increase your scores to some extent through preparation a few weeks or months before you take the test, last minute cramming is unlikely to be of further help. The following information may be helpful.

- A general review of your college courses is probably the best preparation for the test. However, the test covers a broad range of subject matter, and no one is expected to be familiar with the content of every question.
- Become familiar with the types of questions in the GRE Physics Test, paying special attention to the directions. If you thoroughly understand the directions before you take the test, you will have more time during the test to focus on the questions themselves.

Test-Taking Strategies

The questions in the practice test illustrate the types of multiple-choice questions in the test.

The following are some general test-taking strategies you may want to consider.

- Read the test directions carefully, and work as rapidly as you can without being careless. For each question, choose the best answer from the available options.
- All questions are of equal value; do not waste time pondering individual questions you find extremely difficult or unfamiliar.
- You may want to work through the test quickly, first answering only the questions about which you feel confident, then going back and answering questions that require more thought, and concluding with the most difficult questions if there is time.
- Your score will be determined by the number of questions you answer correctly. Questions you answer incorrectly or for which you mark no answer or more than one answer are counted as incorrect. Nothing is subtracted from a score if you answer a question incorrectly. Therefore, to maximize your score it is better for you to guess at an answer than not to respond at all.

What Your Scores Mean

Total Scaled Score

The number of questions you answered correctly on the entire test (total correct score) is converted to the total scaled score for score reporting. This conversion ensures that a scaled score reported for any edition of a GRE Physics Test is comparable to the same scaled score earned on any other edition of the test. Thus, equal scaled scores on a particular test indicate essentially equal levels of performance regardless of the test edition taken.

GRE Physics Test total scaled scores are reported on a 200 to 990 score scale in ten-point increments. Total scaled scores should be compared only with other scores on the Physics Test. For example, a 780 on the Physics Test is not equivalent to a 780 on the Mathematics Test.

Percent Correct Scores in Content Areas

Three percent correct scores (Classical Mechanics; Electromagnetism; and Quantum Mechanics & Atomic Physics) are reported on a range from 0 to 100 percent. Percent correct scores indicate the percentage of questions you answered correctly within a particular content area.

Note that percent correct scores from one test edition cannot be compared with percent correct scores on other test editions because these scores are not equated. For example, a percent correct score of 80 on Classical Mechanics from one Physics Test edition is not equivalent to a percent correct score of 80 on Classical Mechanics from another Physics Test edition.

Taking the Practice Test

The practice test begins on page 7. The total time that you should allow for this practice test is 2 hours.

It is best to take this practice test under timed conditions. Find a quiet place to take the test and make sure you have a minimum of 2 hours available.

Before you begin the practice test, gather a few sheets of scratch paper for your notes and calculations during the test. When you are ready to begin the test, note the time and begin marking your answers in the test. Stop working on the test when 2 hours have elapsed.

Scoring the Practice Test

The worksheet on page 25 lists the correct answers to the questions. The “Correct Response” columns are provided for you to mark those questions for which you chose the correct answer. The “Content Area” columns indicate the primary content area to which each question contributes.

Mark each question that you answer correctly. Then, add up your correct answers and enter your total number of correct answers in the space labeled “Total Correct” at the bottom of page 25. Next, use the “Total Score” conversion tables on page 26 to find the corresponding total scaled score. For example, suppose you chose the correct answers to 54 of the questions on the test. The “Total Correct” entry in the conversion table of 54 shows that your total scaled score is 880.

To calculate each percent correct score, enter the number of questions you answered correctly in each of the three content areas in the space labeled with the corresponding Questions Correct in Content Area (1–3). Compute each percent correct score by dividing the number of questions you answered correctly in that content area by the total number of questions in the content area, multiplying the value by 100, and rounding to a whole number. For example, suppose you answered 6 of the 14 questions in content area 1 correctly. Your percent correct score 1 would be:

$$(6/14)*100 = 42.9 = 43$$

Evaluating Your Performance

Now that you have scored your test, you may wish to compare your performance with the performance of others who took this test.

The data in the worksheet on page 25 are based on the performance of a sample of the test takers who took the GRE Physics Test in the United States.

The numbers in the column labeled “P+” on the worksheet indicate the percentages of examinees in this sample who answered each question correctly. You may use these numbers as a guide for evaluating your performance on each test question.

Interpretive data based on the scores earned by a recent cohort of test takers are available on the GRE website at www.ets.org/gre/test-takers/subject-tests/scores/understand-scores.html. The interpretive data show, for each scaled score, the percentage of test takers who received lower scores. To compare yourself with this population, look at the percentage next to the scaled score you earned on the practice test. Note that these interpretive data are updated annually and reported on GRE score reports.

Your three percent correct scores provide information about your strengths or weaknesses in the three content areas of the Physics Test. You may wish to concentrate your review efforts on topics in content areas where your percent correct scores are lower than other areas.

It is important to realize that the conditions under which you tested yourself will not be exactly the same as those you will encounter during your actual test administration. It is impossible to predict how different test-taking conditions will affect test performance, and this is only one factor that may account for differences between your practice test scores and your actual test scores. By comparing your performance on this practice test with the performance of other individuals who took the GRE Physics Test, however, you will be able to determine your strengths and weaknesses and can then plan a program of study to prepare yourself for taking the GRE Physics Test under standard conditions.

GRADUATE RECORD EXAMINATIONS®

PHYSICS PRACTICE TEST

FORM GR1775

TABLE OF INFORMATION

Rest mass of the electron	$m_e = 9.11 \times 10^{-31} \text{ kg}$
Magnitude of the electron charge	$e = 1.60 \times 10^{-19} \text{ C}$
Avogadro's number	$N_A = 6.02 \times 10^{23}$
Universal gas constant	$R = 8.31 \text{ J/(mol} \cdot \text{K)}$
Boltzmann's constant	$k = 1.38 \times 10^{-23} \text{ J/K}$
Speed of light	$c = 3.00 \times 10^8 \text{ m/s}$
Planck's constant	$h = 6.63 \times 10^{-34} \text{ J} \cdot \text{s} = 4.14 \times 10^{-15} \text{ eV} \cdot \text{s}$ $\hbar = h/2\pi$ $hc = 1240 \text{ eV} \cdot \text{nm}$
Vacuum permittivity	$\epsilon_0 = 8.85 \times 10^{-12} \text{ C}^2/(\text{N} \cdot \text{m}^2)$
Vacuum permeability	$\mu_0 = 4\pi \times 10^{-7} \text{ T} \cdot \text{m/A}$
Universal gravitational constant	$G = 6.67 \times 10^{-11} \text{ m}^3/(\text{kg} \cdot \text{s}^2)$
Acceleration due to gravity	$g = 9.80 \text{ m/s}^2$
1 atmosphere pressure	$1 \text{ atm} = 1.0 \times 10^5 \text{ N/m}^2 = 1.0 \times 10^5 \text{ Pa}$
1 angstrom	$1 \text{ \AA} = 1 \times 10^{-10} \text{ m} = 0.1 \text{ nm}$

Prefixes for Powers of 10

10^{-15}	femto	f
10^{-12}	pico	p
10^{-9}	nano	n
10^{-6}	micro	μ
10^{-3}	milli	m
10^{-2}	centi	c
10^3	kilo	k
10^6	mega	M
10^9	giga	G
10^{12}	tera	T
10^{15}	peta	P

Rotational inertia about center of mass

Rod	$\frac{1}{12} M\ell^2$
Disc	$\frac{1}{2} MR^2$
Sphere	$\frac{2}{5} MR^2$

PHYSICS PRACTICE TEST

Time—120 minutes

70 Questions

Directions: Each of the questions or incomplete statements below is followed by five suggested answers or completions. In each case, select the one that is best and then circle the corresponding letter (i.e., A, B, C, D, or E).

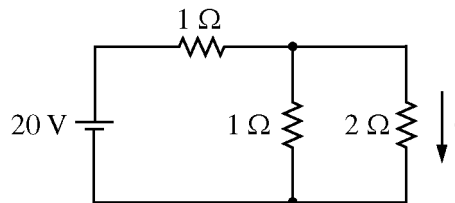
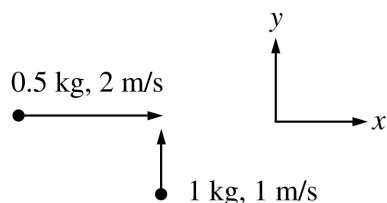

- Two objects sliding on a frictionless surface, as represented above, collide and stick together. How much kinetic energy is converted to heat during the collision?
 - $\frac{1}{9}$ J
 - $\frac{1}{6}$ J
 - $\frac{1}{2}$ J
 - $\frac{3}{4}$ J
 - $\frac{5}{6}$ J
- Two simple pendulums A and B consist of identical masses suspended from strings of length L_A and L_B , respectively. The two pendulums oscillate in equal gravitational fields. If the period of pendulum B is twice the period of pendulum A , which of the following is true of the lengths of the two pendulums?
 - $L_B = \frac{1}{4} L_A$
 - $L_B = \frac{1}{2} L_A$
 - $L_B = L_A$
 - $L_B = 2L_A$
 - $L_B = 4L_A$
- For the circuit shown in the figure above, what is the current i through the 2Ω resistor?
 - 2 A
 - 4 A
 - 5 A
 - 10 A
 - 20 A
- By definition, the electric displacement current through a surface S is proportional to the
 - magnetic flux through S
 - rate of change of the magnetic flux through S
 - time integral of the magnetic flux through S
 - electric flux through S
 - rate of change of the electric flux through S
- The electric field of a plane electromagnetic wave of wave number k and angular frequency ω is given by $\mathbf{E} = E_0(\mathbf{e}_x + \mathbf{e}_y) \sin(kz - \omega t)$. Which of the following gives the direction of the associated magnetic field \mathbf{B} ?
 - \mathbf{e}_z
 - $-\mathbf{e}_x + \mathbf{e}_y$
 - $-\mathbf{e}_x - \mathbf{e}_y$
 - $\mathbf{e}_x - \mathbf{e}_z$
 - $\mathbf{e}_y - \mathbf{e}_z$

6. Which of the following is true about any system that undergoes a reversible thermodynamic process?
- There are no changes in the internal energy of the system.
 - The temperature of the system remains constant during the process.
 - The entropy of the system and its environment remains unchanged.
 - The entropy of the system and its environment must increase.
 - The net work done by the system is zero.
7. For which of the following thermodynamic processes is the increase in the internal energy of an ideal gas equal to the heat added to the gas?
- Constant temperature
 - Constant volume
 - Constant pressure
 - Adiabatic
 - Cyclic
8. Light of variable frequency ν shines on the metal surface of a photoelectric tube. Einstein's theory of the photoelectric effect predicts that the
- work function of the metal is proportional to the frequency
 - work function of the metal is proportional to the wavelength
 - current in the tube is a linear function of the wavelength
 - potential difference necessary to stop the emitted electrons is a linear function of the frequency above the threshold frequency
 - potential difference necessary to stop the emitted electrons is equal to the work function
9. Characteristic X rays, appearing as sharp lines on a continuous background, are produced when high-energy electrons bombard a metal target. Which of the following processes results in the characteristic X rays?
- Electrons producing Čerenkov radiation
 - Electrons colliding with phonons in the metal
 - Electrons filling inner shell vacancies that are created in the metal atoms
 - Electrons combining with protons to form neutrons
 - Electrons undergoing Coulomb scattering with nuclei
10. A single-electron atom has the electron in the $\ell = 2$ state. The number of allowed values of the quantum number m_ℓ is
- 1
 - 2
 - 3
 - 4
 - 5
11. A particle of mass m is confined inside a one-dimensional box (infinite square well) of length a . The particle's ground state energy is which of the following?
- $\frac{\hbar}{8ma}$
 - $\frac{\hbar^2}{8ma^2}$
 - $\frac{\hbar^2}{ma^2}$
 - $\frac{\hbar^2 \pi^2}{2ma^2}$
 - $\frac{\hbar^2 a^2}{2mc^2}$
12. The Planck length is the only combination of the factors G (Newton's gravitational constant), \hbar (Planck's constant / 2π), and c (the speed of light) that has units of length. Which of the following gives the Planck length?
- $\left(\frac{\hbar G}{c^3}\right)^{1/2}$
 - $\frac{\hbar G}{c^3}$
 - $\frac{G^2}{\hbar c}$
 - $\hbar c G$
 - $\frac{\hbar G}{c}$

13. The speed of light inside of a nonmagnetic dielectric material with a dielectric constant of 4.0 is
- (A) 1.2×10^9 m/s
 (B) 3.0×10^8 m/s
 (C) 1.5×10^8 m/s
 (D) 1.0×10^8 m/s
 (E) 7.5×10^7 m/s
14. Consider two identical systems, 1 and 2, each consisting of a planet in circular orbit about a much heavier star. For system 1 the radius of the orbit is a , and for system 2 the radius of the orbit is $4a$. Which of the following gives the ratio, $\frac{T_1}{T_2}$, of the period of system 1 to the period of system 2?
- (A) $\frac{T_1}{T_2} = 1$
 (B) $\frac{T_1}{T_2} = \frac{1}{2}$
 (C) $\frac{T_1}{T_2} = \frac{1}{4}$
 (D) $\frac{T_1}{T_2} = \frac{1}{8}$
 (E) $\frac{T_1}{T_2} = \frac{1}{16}$
15. Two identical satellites, A and B , are in circular orbits around Earth. The orbital radius of A is twice that of B . Which of the following gives the ratio of the angular momentum of A to the angular momentum of B ?
- (A) 4
 (B) 2
 (C) $\sqrt{2}$
 (D) $\frac{1}{\sqrt{2}}$
 (E) $\frac{1}{2}$
16. A 10 kg box slides horizontally without friction at a speed of 1 m/s. At one point, a constant force is applied to the box in the direction of its motion. The box travels 5 m with the constant force applied. The force is then removed, leaving the box with a speed of 2 m/s. Which of the following gives the magnitude of the applied force?
- (A) 1 N
 (B) 2 N
 (C) 3 N
 (D) 4 N
 (E) 5 N
17. What is the magnitude of the magnetic field at the center of a circular conducting loop of radius a that is carrying current I ?
- (A) $4\pi\mu_0 I a^2$
 (B) $\mu_0 I a$
 (C) 0
 (D) $\frac{\mu_0 I}{2a}$
 (E) $\frac{\mu_0 I}{4\pi a^2}$
18. Let ω_p , ω_d , and ω_α be the cyclotron frequencies of protons, deuterons, and alpha particles, respectively, in the same magnetic field. The frequencies are related by which of the following? (Assume that the particle masses are in the ratio 1 : 2 : 4.)
- (A) $\omega_p = \omega_d = \omega_\alpha$
 (B) $\omega_p = \omega_d > \omega_\alpha$
 (C) $\omega_p = \omega_d < \omega_\alpha$
 (D) $\omega_p < \omega_d = \omega_\alpha$
 (E) $\omega_p > \omega_d = \omega_\alpha$

19. The emission spectrum of the doubly ionized lithium atom Li^{++} ($Z = 3$, $A = 7$) is identical to that of a hydrogen atom in which all the wavelengths are

- (A) decreased by a factor of 9
 (B) decreased by a factor of 49
 (C) decreased by a factor of 81
 (D) increased by a factor of 9
 (E) increased by a factor of 81

20. In an atom of hydrogen, the electron is bound to a proton. In an atom of positronium, the electron is bound to a positron instead of a proton. Which of the following gives the approximate Rydberg constant for positronium? (For a nucleus of

infinite mass, $R_\infty = \frac{m_e e^4}{8\epsilon_0^2 ch^3}$.)

- (A) $0.0005R_\infty$
 (B) $0.5R_\infty$
 (C) $0.999R_\infty$
 (D) $2R_\infty$
 (E) $1880R_\infty$

21. Which of the following gives the total spin quantum number of the electrons in the ground state of neutral nitrogen ($Z = 7$) ?

- (A) $\frac{1}{2}$
 (B) 1
 (C) $\frac{3}{2}$
 (D) $\frac{5}{2}$
 (E) $\frac{7}{2}$

22. Consider a Hermitian operator \hat{A} with the property $\hat{A}^4 = 1$. Which of the following is an allowed pair of eigenvalues of \hat{A} ?

- (A) 0, 1
 (B) 1, -1
 (C) 1, i
 (D) 1, $-i$
 (E) $1 + i$, $1 - i$

$$\hat{T} \equiv \frac{\hat{p}^2}{2m}$$

$$\hat{H} \equiv \frac{\hat{p}^2}{2m} + V(\hat{x})$$

23. Consider the kinetic energy operator \hat{T} and the Hamiltonian operator \hat{H} above. Which of the following pairs of observables can be measured simultaneously with no restriction on their precision?

- (A) \hat{x} and \hat{p}
 (B) \hat{x} and \hat{T}
 (C) \hat{H} and \hat{p}
 (D) \hat{H} and \hat{T}
 (E) \hat{T} and \hat{p}

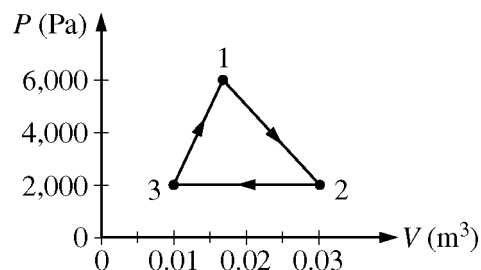

24. A sample of nitrogen gas undergoes the cyclic thermodynamic process shown above. Which of the following gives the net heat transferred to the system in one complete cycle $1 \rightarrow 2 \rightarrow 3 \rightarrow 1$?

- (A) -80 J
 (B) -40 J
 (C) 40 J
 (D) 80 J
 (E) 180 J

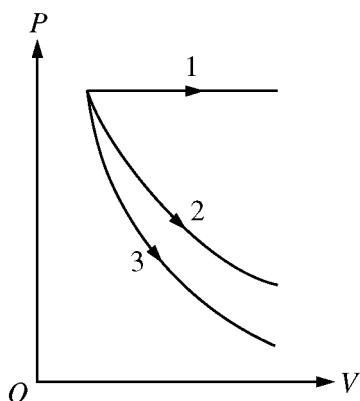

25. For an ideal gas, consider the three thermodynamic processes—labeled 1, 2, and 3—shown in the PV diagram above. Each process has the same initial state and the same final volume. One process is adiabatic, one is isobaric, and one is isothermal. Which of the following correctly identifies the three processes?

	<u>Adiabatic</u>	<u>Isobaric</u>	<u>Isothermal</u>
(A)	1	2	3
(B)	2	1	3
(C)	2	3	1
(D)	3	1	2
(E)	3	2	1

26. The driver of a police car hears an echo of the car's siren from a wall toward which the car is moving with a speed of 3.5 m/s. If the speed of sound is 350 m/s and the frequency of the siren is 600 Hz, the driver hears the echo at a frequency nearest to which of the following?
- (A) 588 Hz
 (B) 594 Hz
 (C) 600 Hz
 (D) 606 Hz
 (E) 612 Hz
27. The first five harmonics produced by an organ pipe open at both ends are 50 Hz, 100 Hz, 150 Hz, 200 Hz, and 250 Hz. Which of the harmonics, if any, will survive once the pipe is closed at one end?
- (A) 50 Hz, 150 Hz, and 250 Hz only
 (B) 100 Hz and 200 Hz only
 (C) 150 Hz and 250 Hz only
 (D) 200 Hz only
 (E) None

28. A refracting telescope consists of two converging lenses separated by 100 cm. The eye-piece lens has a focal length of 20 cm. The angular magnification of the telescope is

(A) 4
 (B) 5
 (C) 6
 (D) 20
 (E) 100

29. A particle decays in $2.0 \mu\text{s}$ in its rest frame. If the same particle moves at $v = 0.60c$ in the lab frame, how far will it travel in the lab before decaying?

(A) 150 m
 (B) 288 m
 (C) 360 m
 (D) 450 m
 (E) 750 m

30. The rest mass of a particle with total energy 5.0 GeV and momentum 4.9 GeV/c is approximately

(A) 0.1 GeV/c²
 (B) 0.2 GeV/c²
 (C) 0.5 GeV/c²
 (D) 1.0 GeV/c²
 (E) 1.5 GeV/c²

31. If charge $+Q$ is located in space at the point $(x = 1 \text{ m}, y = 10 \text{ m}, z = 5 \text{ m})$, what is the total electric flux that passes through the yz -plane?

(A) ∞
 (B) 1
 (C) $\frac{Q}{\epsilon_0}$
 (D) $\frac{Q}{2\epsilon_0}$
 (E) 0

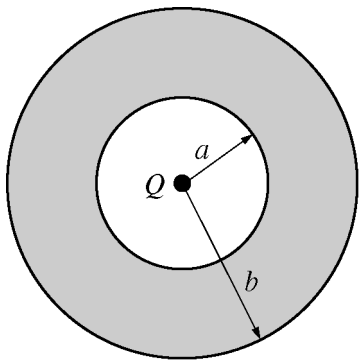

32. A point charge Q is placed at the center of a hollow, conducting spherical shell of inner radius a and outer radius b , as shown above. A net charge q is placed on the conducting shell. If the electric potential is assumed to be 0 at infinity, the magnitude of the electric potential at r , where $a < r < b$, is

- (A) 0
 (B) $\frac{Q}{4\pi\epsilon_0 r}$
 (C) $\frac{Q + q}{4\pi\epsilon_0 r}$
 (D) $\frac{Q}{4\pi\epsilon_0 a}$
 (E) $\frac{Q + q}{4\pi\epsilon_0 b}$

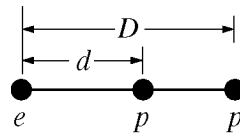

(1)

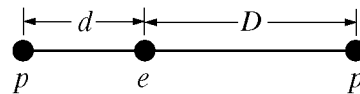

(2)

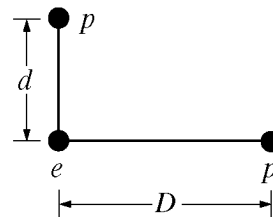

(3)

33. The figure above shows three arrangements of one electron (e) and two protons (p). Which of the following is true about the magnitude F of the net electrostatic force acting on the electron due to the protons?
- (A) $F_1 > F_2 > F_3$
 (B) $F_1 = F_2 > F_3$
 (C) $F_1 > F_3 > F_2$
 (D) $F_2 > F_1 > F_3$
 (E) $F_2 > F_3 > F_1$

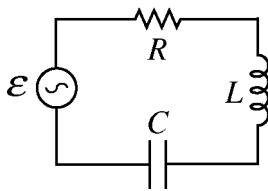

34. A series AC circuit with impedance Z consists of resistor R , inductor L , and capacitor C , as shown above. The ideal emf source has a sinusoidal output given by $\mathcal{E} = \mathcal{E}_{\max} \sin \omega t$, and the current is given by $I = I_{\max} \sin(\omega t - \phi)$. What is the average power dissipated in the circuit? (I_{rms} is the root-mean-square current.)

- (A) $I_{\text{rms}}^2 R$
 (B) $\frac{1}{2} I_{\text{rms}}^2 R$
 (C) $\frac{1}{2} I_{\text{rms}}^2 Z$
 (D) $\frac{1}{2} I_{\text{rms}}^2 R \cos \phi$
 (E) $\frac{1}{2} I_{\text{rms}}^2 Z \cos \phi$

35. The quantum efficiency of a photon detector is 0.1. If 100 photons are sent into the detector, one after the other, the detector will detect photons
- (A) exactly 10 times
 (B) an average of 10 times, with an rms deviation of about 0.1
 (C) an average of 10 times, with an rms deviation of about 1
 (D) an average of 10 times, with an rms deviation of about 2
 (E) an average of 10 times, with an rms deviation of about 3

36. Two students perform an experiment in which they drop a ball from rest from a known height above the ground and measure the speed of the ball just before it strikes the ground. From repeated measurement, the students estimate the uncertainty in the measured speed of the ball to be 10 percent. Which of the following gives the uncertainty in the kinetic energy of the ball? (Assume the uncertainty in the ball's mass is negligibly small.)

- (A) 5%
 (B) 10%
 (C) 15%
 (D) 20%
 (E) 40%

37. A particle in an infinite square well has as its initial wave function an equal mixture of the first three orthonormal stationary states: $\Psi(x, 0) = A[\psi_1(x) + \psi_2(x) + \psi_3(x)]$. The value of the normalization constant A is equal to which of the following?

- (A) $\frac{1}{\sqrt{3}}$
 (B) $\frac{1}{\sqrt{2}}$
 (C) 1
 (D) $\sqrt{2}$
 (E) $\sqrt{3}$

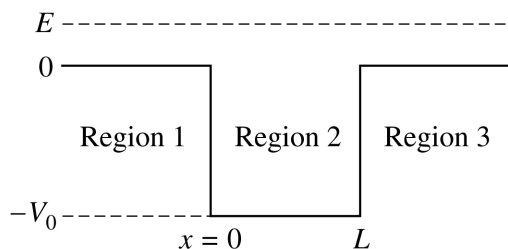

38. A matter wave of energy $E > 0$ and wave number k is incident from the left on a potential well of width L and depth V_0 . The top of the well is at zero energy and the bottom of the well is at $-V_0$, as shown in the figure above. The spatial part of the wave function in region 3 has which of the following forms? (A is a constant.)

- (A) Ae^{ikx}
 (B) $A \sin kx$
 (C) $A \cos kx$
 (D) $Ae^{ik'x}$ ($k' < k$)
 (E) $Ae^{-\kappa x}$ (κ real and positive)

39. Spring 1 has force constant k_1 and spring 2 has force constant k_2 , where $k_1 > k_2$. If the same external force is applied to both springs, which of the following is true about the extensions (Δx_1 and Δx_2) and the stored potential energies (U_1 and U_2) of the two springs?

<u>Extension</u>	<u>Stored Potential Energy</u>
(A) $\Delta x_1 < \Delta x_2$	$U_1 < U_2$
(B) $\Delta x_1 < \Delta x_2$	$U_1 > U_2$
(C) $\Delta x_1 = \Delta x_2$	$U_1 < U_2$
(D) $\Delta x_1 = \Delta x_2$	$U_1 = U_2$
(E) $\Delta x_1 > \Delta x_2$	$U_1 = U_2$

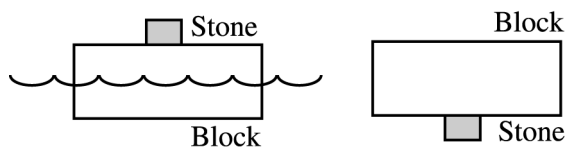
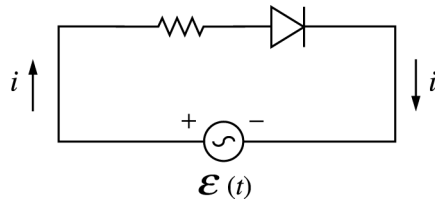

Figure 1

Figure 2

40. A stone is glued to the top of a light wooden block that floats in a pool of water, as shown in Figure 1 above. Assume that exactly 50 percent of the block is under water, and that the stone has half the weight of the block. If the block and stone are flipped over, as shown in Figure 2, and replaced in the pool, the amount of the block under water will be
- (A) less than 50%
 (B) still 50%
 (C) between 50% and 75%
 (D) between 75% and 100%
 (E) 100%, since the stone and block sink
41. A uniform solid disk starts from rest and rolls down an inclined plane without slipping. After some time, what fraction of the disk's total kinetic energy is rotational kinetic energy?
- (A) $\frac{1}{4}$
 (B) $\frac{1}{3}$
 (C) $\frac{1}{2}$
 (D) $\frac{2}{3}$
 (E) $\frac{3}{4}$

42. A grating spectrometer can just barely resolve two wavelengths of 500 nm and 502 nm, respectively. Which of the following gives the resolving power of the spectrometer?
- (A) 2
 (B) 250
 (C) 5,000
 (D) 10,000
 (E) 250,000
43. A gas cell with an optical path length of 10 cm is placed in one arm of a Michelson interferometer. If the light source for the interferometer is a laser with wavelength $\lambda = 632.2$ nm, then 100 fringes are counted as the gas cell is evacuated. What is the index of refraction of the original gas?
- (A) 1.00063
 (B) 1.00032
 (C) 1.00016
 (D) 0.99968
 (E) -1.00016



44. The AC circuit shown above contains an ideal rectifying diode. If the function generator supplies $\mathcal{E}(t) = V_0 \sin \omega t$, which of the following describes the voltage across the resistor?

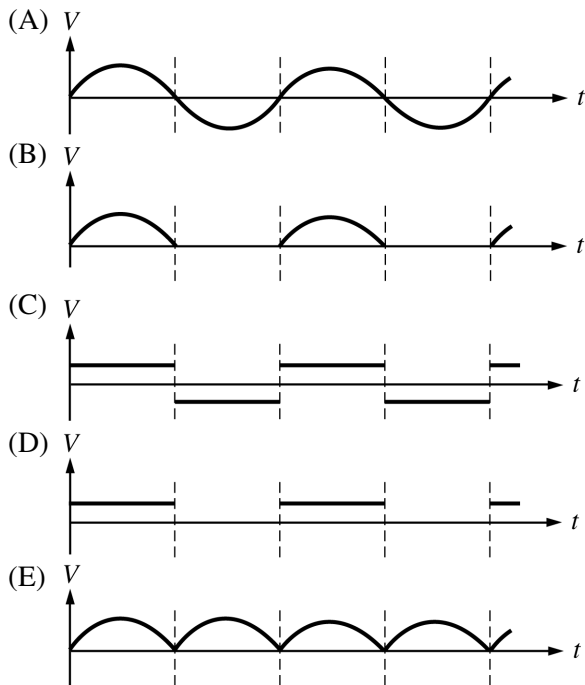

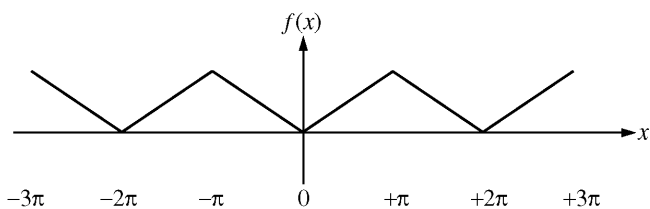

45. The Fourier series expansion of a function $f(x)$ that is periodic with period 2π is

$$f(x) = \frac{a_0}{2} + \sum_{n=1}^{\infty} a_n \cos(nx) + \sum_{n=1}^{\infty} b_n \sin(nx).$$

If $f(x)$ is given by the graph above, which of the following statements about the coefficients is true?

- (A) $a_n = 0$ for all n
- (B) $b_n = 0$ for all n
- (C) $a_n = 0$ for even n only
- (D) $b_n = 0$ for even n only
- (E) $a_n = b_n$ for all n

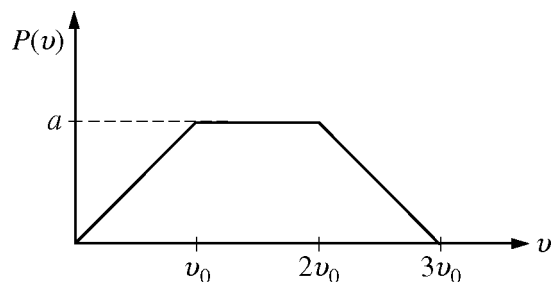

46. A sample of N molecules has the distribution of speeds shown in the figure above. $P(v)dv$ is an estimate of the number of molecules with speeds between v and $v + dv$, and this number is nonzero only up to $3v_0$, where v_0 is constant. Which of the following gives the value of a ?

- (A) $a = \frac{N}{3v_0}$
- (B) $a = \frac{N}{2v_0}$
- (C) $a = \frac{N}{v_0}$
- (D) $a = \frac{3N}{2v_0}$
- (E) $a = N$

47. Which of the following statements is (are) true for a Maxwell-Boltzmann description of an ideal gas of atoms in equilibrium at temperature T ?

- I. The average velocity of the atoms is zero.
- II. The distribution of the speeds of the atoms has a maximum at $v = 0$.
- III. The probability of finding an atom with zero kinetic energy is zero.

- (A) I only
- (B) II only
- (C) I and II
- (D) I and III
- (E) II and III

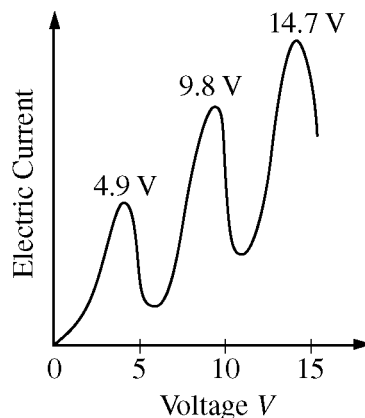
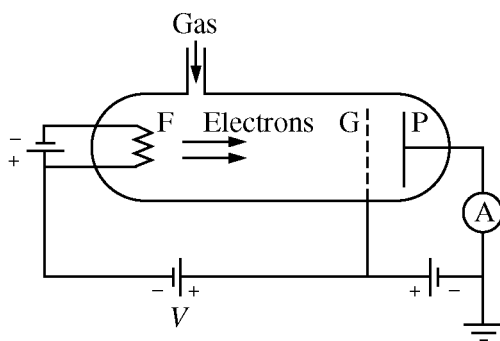

48. Low-energy electrons are accelerated between electrodes in a tube filled with a gas in the Franck-Hertz apparatus represented above. A plot of current collected versus accelerating voltage is also shown. The data provide evidence for which of the following?

- (A) Electronic energy losses due only to elastic collisions
- (B) Excitation energies of the gas atoms of 4.9, 9.8, and 14.7 eV
- (C) Excitation energy of the gas atoms of 4.9 eV only
- (D) Atomic energy levels of -4.9 , -9.8 , and -14.7 eV
- (E) Atomic energy levels of -4.9 and -9.8 eV only

49. A particle of mass m and spin zero is in a three-dimensional isotropic well described

$$\text{by } V(r) = \frac{1}{2}m\omega^2 r^2, \text{ where } r^2 = x^2 + y^2 + z^2.$$

How many states have energy $\frac{7}{2}\hbar\omega$?

- (A) 1
- (B) 2
- (C) 4
- (D) 6
- (E) 8

50. The operators for the total angular momentum and its three projections are $\hat{\mathbf{J}}$ and \hat{J}_x , \hat{J}_y , \hat{J}_z , respectively. The commutator between two operators \hat{A} and \hat{B} is $[\hat{A}, \hat{B}] \equiv \hat{A}\hat{B} - \hat{B}\hat{A}$. Which of the following is true?

- (A) $[\hat{\mathbf{J}}^2, \hat{J}_z] = 0$
- (B) $[\hat{\mathbf{J}}^2, \hat{J}_z] = i\hbar\hat{J}_y$
- (C) $[\hat{J}_x, \hat{J}_y] = 0$
- (D) $[\hat{J}_x, \hat{J}_z] = i\hbar\hat{J}_z$
- (E) $[\hat{J}_x + i\hat{J}_y, \hat{J}_z] = 0$

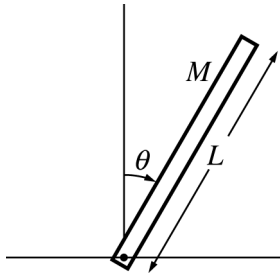

51. A uniform rod of length L and mass M is released from rest at $\theta = 0$ and rotates about a horizontal axis through its base, as shown in the figure above. What is the angular acceleration of the rod as a function of θ ? (Ignore the effects of friction and air resistance.)

- (A) $\frac{g}{2L}$
- (B) $\frac{g}{L}\theta$
- (C) $\frac{6g}{L}\cos\theta$
- (D) $\frac{3g}{2L}\sin\theta$
- (E) $\frac{12g}{L}\sin\theta$

52. A block attached to a spring is moving along the x -axis on a frictionless horizontal surface. What is the Hamiltonian for the block?

- (A) $H = 0$
- (B) $H = -kx$
- (C) $H = \frac{k}{2}x^2$
- (D) $H = \frac{p^2}{2m} - \frac{k}{2}x^2$
- (E) $H = \frac{p^2}{2m} + \frac{k}{2}x^2$

53. A magnetic field is directed perpendicular to the plane of a circular coil of area 0.2 m^2 and 250 turns. If the magnetic field is increased from 0.01 T to 0.06 T during a time interval of 0.25 s , the average induced EMF in the coil is

- (A) 0.04 V
- (B) 0.1 V
- (C) 2.5 V
- (D) 10 V
- (E) 50 V

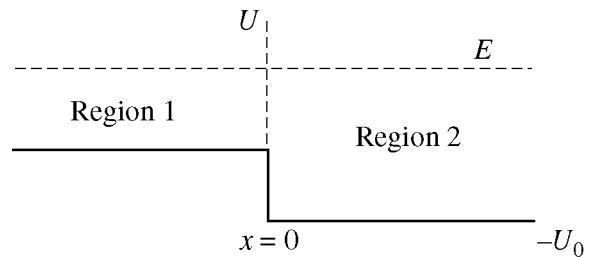

54. The figure above depicts a step potential with $U(x) = 0$, for $x \leq 0$ (region 1),
 $U(x) = -U_0$, for $x > 0$ (region 2).

A beam of particles with $E > 0$ is incident from the left. The momentum of the particle in each region has the form $\hbar k$. The reflection coefficient R for the interface at $x = 0$ is

- (A) $R = 0$
- (B) $R = \frac{4k_1k_2}{(k_1 + k_2)^2}$
- (C) $R = \frac{(k_1 + k_2)^2}{(k_1 - k_2)^2}$
- (D) $R = \frac{(k_1 - k_2)^2}{(k_1 + k_2)^2}$
- (E) $R = \frac{-4k_1k_2}{(k_1 + k_2)^2}$

55. Consider the Pauli spin matrices σ_x , σ_y , and σ_z . The product $\sigma_x \sigma_y$ is equal to which of the following?

- (A) 0
- (B) σ_z
- (C) $-\sigma_z$
- (D) $\sigma_y \sigma_x$
- (E) $-\sigma_y \sigma_x$

56. The binding energy per nucleon is greatest for which of the following nuclei?

- (A) ${}^3_2\text{He}$
- (B) ${}^4_2\text{He}$
- (C) ${}^{56}_{26}\text{Fe}$
- (D) ${}^{235}_{92}\text{U}$
- (E) ${}^{238}_{92}\text{U}$

57. The negative muon, μ^- , has properties most similar to which of the following?

- (A) Quark
- (B) Boson
- (C) Photon
- (D) Meson
- (E) Electron

58. Which of the following correctly gives the quark and antiquark content of a lepton and a baryon?

	<u>Lepton</u>		<u>Baryon</u>	
	<u>Quarks</u>	<u>Antiquarks</u>	<u>Quarks</u>	<u>Antiquarks</u>
(A)	0	0	3	0
(B)	0	0	1	1
(C)	1	0	1	1
(D)	1	1	2	0
(E)	1	1	3	0

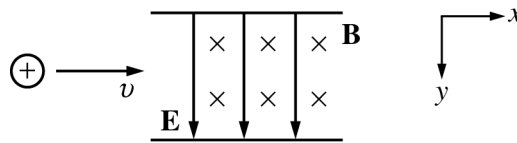

59. A beam of positive ions is initially moving in the $+x$ -direction with nonrelativistic velocity. The beam enters a velocity selector in which the electric field \mathbf{E} is oriented along the $+y$ -direction and the magnetic field \mathbf{B} is oriented along the $+z$ -direction, as shown above. Which of the following gives the critical speed v_c at which the ion beam is not deflected as it moves through the velocity selector?

- (A) $v_c = EB$
- (B) $v_c = \frac{1}{EB}$
- (C) $v_c = \frac{B^2}{E}$
- (D) $v_c = \frac{B}{E}$
- (E) $v_c = \frac{E}{B}$

60. Under ideal conditions, the electric and magnetic fields inside a superconductor are zero. Maxwell's equations imply that which of the following must be true just outside the surface of the superconductor?

- (A) $\mathbf{B} = \mathbf{0}$
- (B) \mathbf{B} is perpendicular to the surface.
- (C) \mathbf{B} is tangential to the surface.
- (D) \mathbf{B} is time independent.
- (E) The magnetic flux is quantized.

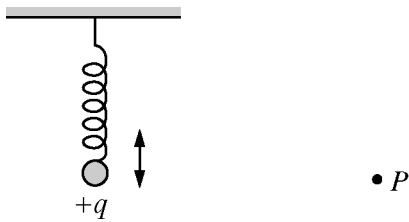

61. A positive charge, $+q$, oscillates up and down, as represented in the figure above. What is the direction of the Poynting vector \mathbf{S} at point P ? (Assume P is located far to the right of $+q$.)
- (A) Toward the left
 (B) Toward the right
 (C) Toward the top of the page
 (D) Toward the bottom of the page
 (E) Into the page

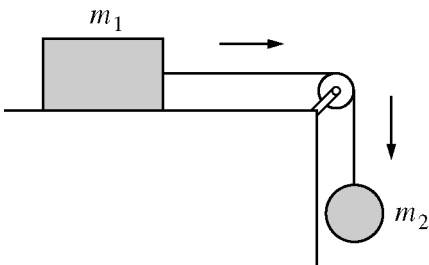

62. A block with mass m_1 that slides on a frictionless table is attached by a massless string over a massless, frictionless pulley to a hanging ball with mass m_2 , as shown in the figure above. The tension in the string must be
- (A) equal to m_2g
 (B) greater than m_2g
 (C) less than m_2g
 (D) equal to m_1g
 (E) greater than m_1g

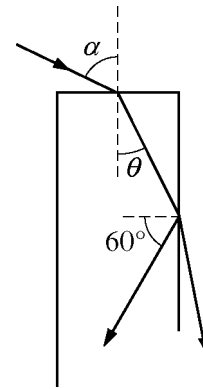

63. As represented in the figure above, a light ray refracts from air into a rectangular block of plastic with an index of refraction $n > 1$. At a point on the side of the block, the ray partly reflects (at an angle of 60°) and partly refracts. The value of the angle α is
- (A) 30°
 (B) 60°
 (C) $\cos^{-1} \frac{n}{2}$
 (D) $\sin^{-1} \frac{n}{2}$
 (E) $\tan^{-1} n$
64. The hydrogen lines observed in the spectrum of the quasar 3C9 are shifted so far into the red that their wavelengths are three times as long as those observed in the light from hydrogen atoms at rest in a laboratory on Earth. If it is assumed that the shift is entirely due to the relative motion of 3C9 and Earth, the relative speed of the quasar is
- (A) $2c$
 (B) c
 (C) $0.8c$
 (D) $0.5c$
 (E) $0.3c$

65. Protons used in cancer therapy are typically accelerated to about $0.6c$. How much work must be done on a particle of mass m in order for it to reach this speed, assuming it starts at rest?
- (A) $0.25mc^2$
 (B) $0.60mc^2$
 (C) $0.67mc^2$
 (D) $1.25mc^2$
 (E) $1.60mc^2$
66. The sign of the charge carriers in a doped semiconductor can be deduced by measuring which of the following properties?
- (A) Specific heat
 (B) Thermal conductivity
 (C) Electrical resistivity
 (D) Magnetic susceptibility
 (E) Hall coefficient
67. An airplane drops a payload while traveling due north, parallel to the ground, at a constant speed of 100 m/s . If air resistance is neglected, what is the velocity of the payload relative to the plane 4.0 s after it is released?
- (A) $\mathbf{0}$
 (B) 40 m/s down
 (C) 80 m/s down
 (D) 100 m/s north and 40 m/s down
 (E) 100 m/s south and 40 m/s down
68. Two balls, identical in every way except that one has twice the mass of the other, are dropped from rest from the same height so that they both reach terminal speed before hitting the ground. If it is assumed that the drag force varies like the speed squared, what is the ratio of the terminal speeds of the balls? (Note: The subscripts h and l denote the heavy and light masses, respectively.)
- (A) $\frac{v_h}{v_l} = 1$
 (B) $\frac{v_h}{v_l} = \sqrt{2}$
 (C) $\frac{v_h}{v_l} = 2$
 (D) $\frac{v_h}{v_l} = 2\sqrt{2}$
 (E) $\frac{v_h}{v_l} = 4$
69. One end of a horizontal, massless spring is attached to a wall. A mass of 0.30 kg is attached to the other end of the spring and rests on a table. The mass is displaced 0.030 m from its equilibrium position and released. It has a speed of 0.040 m/s as it passes through its equilibrium position. In the absence of friction, what is the total mechanical energy of the system?
- (A) 0.24 mJ
 (B) 0.38 mJ
 (C) 0.48 mJ
 (D) 0.75 mJ
 (E) 0.96 mJ

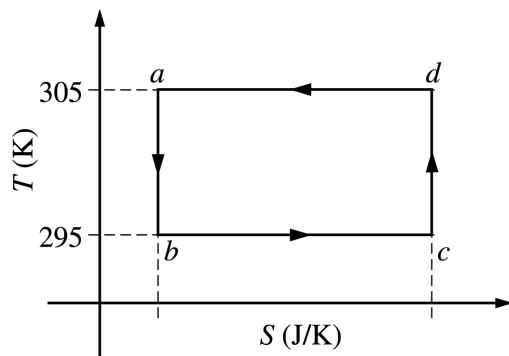

70. The diagram above shows a Carnot cycle for an ideal air conditioner, which is to cool a house on a hot summer day. The air conditioner absorbs heat at the lower temperature inside and pumps it to the environment at the higher temperature outside. Which of the following gives the ratio of the heat Q_{bc} absorbed in the house (i.e., between points b and c on the cycle) to the work done during the cycle?
- (A) 0
 - (B) 0.033
 - (C) 0.97
 - (D) 1.0
 - (E) 30.

Worksheet for the GRE Physics Practice Test, Form GR1775

Answer Key and Percentages* of Test Takers Answering Each Question Correctly

QUESTION		P+	CORRECT RESPONSE	CONTENT AREA		
Number	Answer			1	2	3
1	E	41		*		
2	E	70		*		
3	B	64			*	
4	E	30			*	
5	B	47			*	
6	C	59				
7	B	64				
8	D	59			*	
9	C	41			*	
10	E	79			*	
11	D	77			*	
12	A	76				
13	C	48				
14	D	74		*		
15	C	34		*		
16	C	70		*		
17	D	60			*	
18	E	43		*		
19	A	49			*	
20	B	50			*	
21	C	31			*	
22	B	51			*	
23	E	66			*	
24	C	47				
25	D	63				
26	E	32				
27	E	32				
28	A	39				
29	D	53				
30	D	56				
31	D	52		*		
32	E	24		*		
33	C	86		*		
34	A	23		*		
35	E	28				

QUESTION		P+	CORRECT RESPONSE	CONTENT AREA		
Number	Answer			1	2	3
36	D	44				
37	A	85			*	
38	A	37			*	
39	A	76		*		
40	A	53		*		
41	B	52		*		
42	B	33				
43	B	29				
44	B	56				
45	B	45				
46	B	64				
47	D	46				
48	C	20			*	
49	D	36			*	
50	A	63			*	
51	D	43		*		
52	E	77		*		
53	D	52			*	
54	D	43			*	
55	E	32			*	
56	C	49				
57	E	74				
58	A	53				
59	E	74		*		
60	C	43		*		
61	B	41		*		
62	C	54		*		
63	D	59				
64	C	55				
65	A	38				
66	E	50				
67	B	44		*		
68	B	47		*		
69	A	70		*		
70	E	25				

Total Correct: _____ Scaled Score: _____

Percent Correct Score 1
(Classical Mechanics): = (Questions Correct in Content Area 1 _____ / 14) x 100 = _____ (rounded to nearest whole number).

Percent Correct Score 2
(Electromagnetism): = (Questions Correct in Content Area 2 _____ / 13) x 100 = _____ (rounded to nearest whole number).

Percent Correct Score 3
(Quantum Mechanics & Atomic Physics): = (Questions Correct in Content Area 3 _____ / 16) x 100 = _____ (rounded to nearest whole number).

The reported Percent Correct Scores are rounded to have a range from 0 to 100.

* The numbers in the P+ column indicate the percentages of test takers in the United States who answer each question correctly.

Score Conversions for the GRE Physics Practice Test, Form GR1775

TOTAL SCORE			
Total Correct	Scaled Score	Total Correct	Scaled Score
62-70	990	30	590
61	980	29	580
60	970	28	570
59	950	27	560
		26	550
58	940		
57	930	25	540
56	910	24	530
55	900	23	520
		22	510
54	880	21	500
53	870		
52	860	20	490
		19	480
51	840	18	470
50	830	17	460
49	820	16	450
48	800		
		15	440
47	790	14	430
46	780	13	420
45	760	12	410
44	750	11	400
43	740	10	390
42	720	9	380
41	710	8	370
40	700	7	360
		6	350
39	690		
38	680	5	340
37	660	4	330
36	650	3	320
		2	310
35	640	1	300
34	630		
33	620	0	280
32	610		
31	600		



www.ets.org

153298-007627 • UNLWEB323